

DEFLECTION CONNECTIONS

email: clipexpress@clarkdietrich.com
p: 866.638.1908



The Steel Network













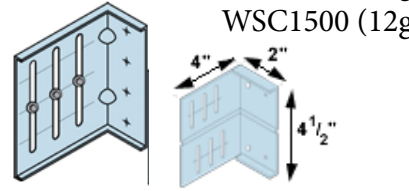
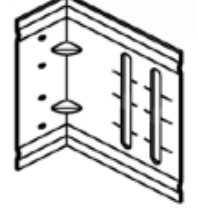

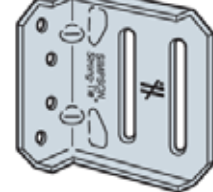
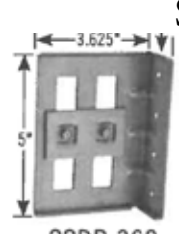
Marino/WARE

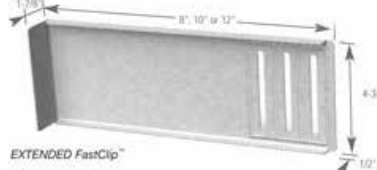
Craco

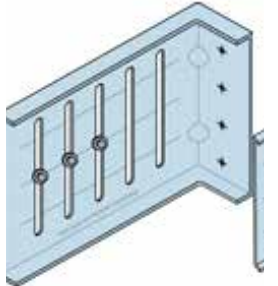
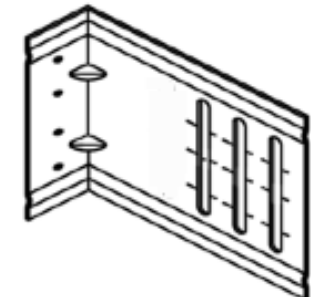
SCAFCO

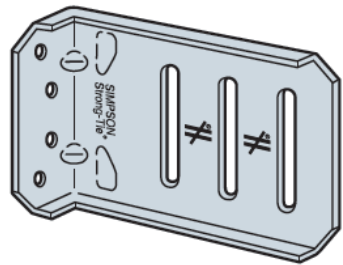
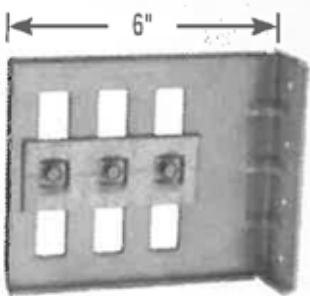
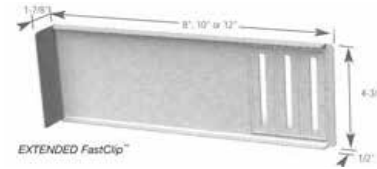
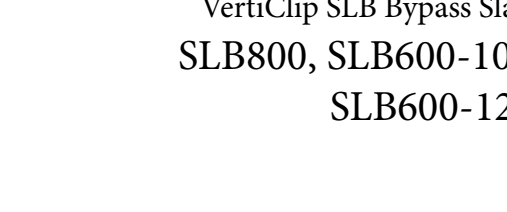
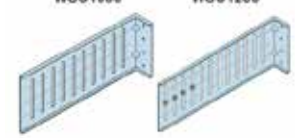
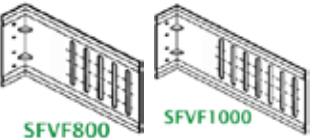
CEMCO/Simpson

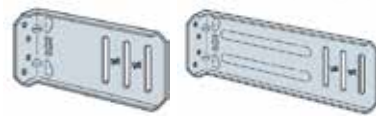
SuperStud

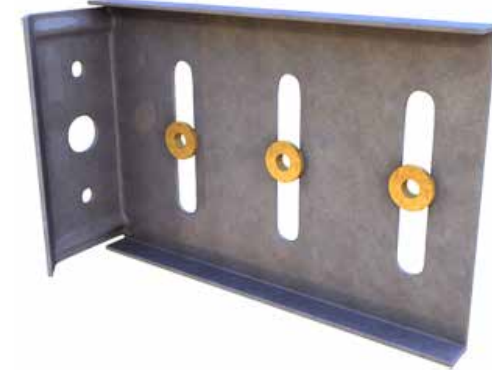
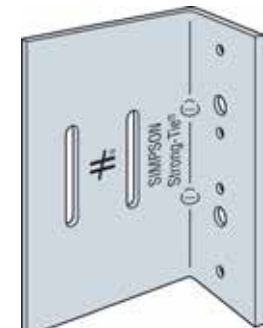
<p>FastClip™ Slide Clip FCSC 3.5</p> 	<p>VertiClip SLB Bypass Slab SLB362</p> 	<p>WSC362 WSC950 (16ga) WSC1500 (12ga)</p> 	<p>SFVF300</p> 	<p>PLC1 & PLC2 Bypass Slab Slide Clip PLC1-350</p> 	<p>SCB43.5</p> 	<p>SSDB362</p> 
<p>FCSC 5.5-14ga FCSC 5.5-12ga</p>  <p>Extended FastClip™ Slide Clip FCEC 6</p> 	<p>VertiClip SLB Bypass Slab SLB600</p> 	<p>WSC600</p> 	<p>SFVF600</p> 	<p>PLC1 & PLC2 Bypass Slab Slide Clip PLC1-550 PLC2-550</p> 	<p>SCB45.5 MSCB45.5</p> 	<p>SSTB600</p> 
<p>FCEC8, FCEC10, FCEC12</p> 	<p>VertiClip SLB Bypass Slab SLB800, SLB600-10", SLB600-12"</p> 	<p>WSC800 WSC1000 WSC1200</p> 	<p>SFVF800, SFVF1000</p> 	<p>PLC1 & PLC2 Bypass Slab Slide Clip PLC1-750, -950 PLC2-750, -950, -1150</p> 	<p>SCB47.5, 49.5, 411.5 MSCB47.5 (14ga)</p> 	<p>SSTB800 SSTB1000 SSTB1200</p> 
<p>FCSC 6" w/Anchor FCSC-HD</p> 	<p>VertiClip SLB-HD</p> 				<p>Heavy Duty ByPass Slide Clip SC32-5/97-KT25 SC62-5/97-KT25 SC62-5/118-KT25 SC82-5/118-KT25</p> 	

DEFLECTION CONNECTIONS

email: clipexpress@clarkdietrich.com
p: 866.638.1908



The Steel Network













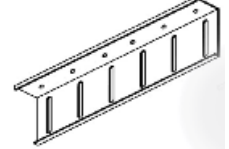

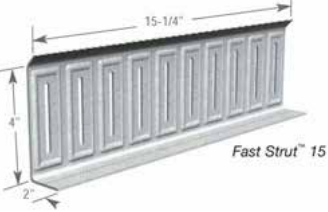

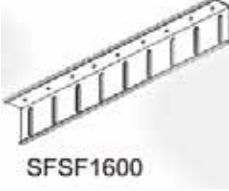

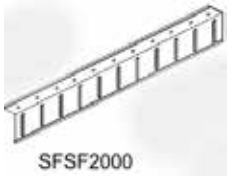
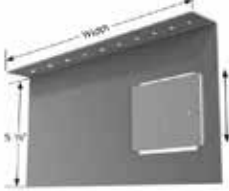
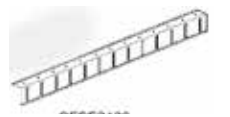

Marino/WARE

Craco

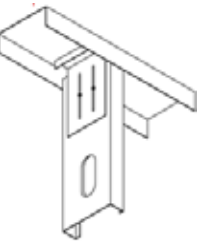
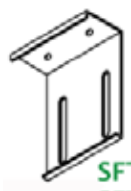
SCAFCO

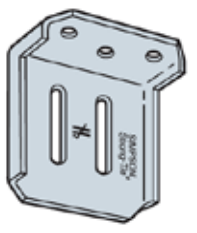
CEMCO/Simpson

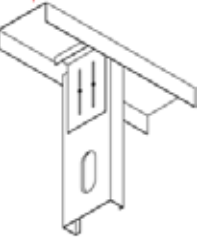
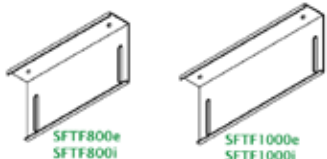
SuperStud

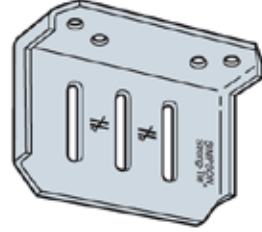
<p>FastStrut™ FS12</p> 	<p>Verticlip SLS Bypass Structure SLS362-12, SLS400-12, SLS600-12</p> 	N/A	<p>SFSF1200</p> 	<p>PLS1-900, -1200 PLS2-900</p> 	N/A	<p>DC1700 DC1500</p>
<p>FS15</p> 	<p>Verticlip SLS Bypass Structure SLS600-15, SLS800-15</p> 	N/A	<p>SFSF1600</p> 	<p>PLS1-1500, PLS2-1500</p> 	N/A	<p>DS1700-16 (L&R) DS1500-16 (L&R)</p> 
<p>FS18</p>	<p>SLS600-18, SLS800-18</p>	 WSC Outrigger 18" only		<p>PLS1-1800, PLS2-1800</p>	<p>SSB3.518 (18" only)</p> 	
<p>FS20</p>	<p>SLS600-20, SLS800-20</p> 		<p>SFSF2000</p> 	<p>PLS1-2000 PLS2-2000</p> 	N/A	
<p>FS22</p>		N/A	N/A	N/A	N/A	
<p>FS24</p>			<p>SFSF2400</p> 			
<p>FastTop™ Clip FTC3</p> 	<p>VertiClip SL362, SLD362, SL400 SLD400</p> 	 3T1000	<p>SFTF300E or I</p>  <p>SFTF300e SFTF300i</p>	<p>Interior Head of Wall Clip ISC337</p> 	<p>SCW3.25</p> 	<p>ITTC 450 3-5/8" SST362 SSTX362</p>
<p>FTC5 FTC8 FTC10 FTC12</p> 	<p>VertiClip SL600 SLD600 SL800 SLD800 SL1000</p> 	 6T1000	<p>SFTF600E or I SFTF800E or I SFTF1000E or I</p>  <p>SFTF800e SFTF800i SFTF1000e SFTF1000i</p>	<p>Interior Head of Wall Clip ISC550, 750, 950</p> 	<p>SCW5.5</p> 	<p>ITTC 450 6" SST600 SSTX600</p>



The Steel Network

Marino/WARE

Craco

SCAFCO

CEMCO/Simpson

SuperStud

Flat Tail Slide Clip™ [FTSC](#)



VertiClip SLT Flat Plate Bypass



SLT9.5"
SLT12"
SLT15"
SLT18"



VertiClip SLF

STP

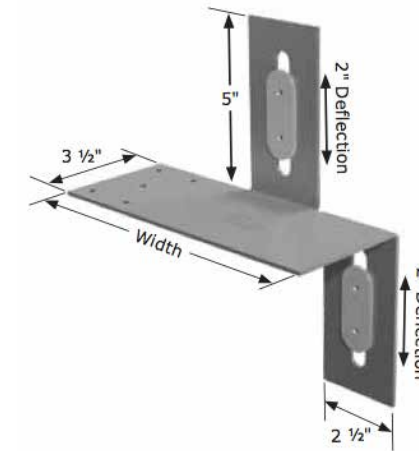

Horizontal
Anchorage
Slide-Clip
SCHA10.75-KT

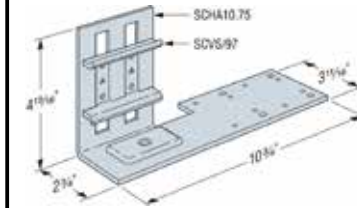

VertiClip Splice Multi-Stud Clip



SSWT

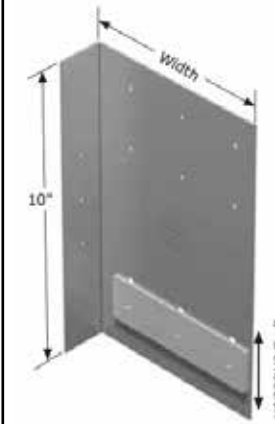

Drift FCSC
[3.5 D-FCSC350](#)
[6 D-FCSC6](#)
[8 D-FCSC8](#)

Driftclip DSLB Bypass Clip
 DSLB362/400
 DSLB600
 DSLB800

DWSC362, 600, 800,
 1000, 1200

DPLC2

IDCB45.5
 (6" only)

HVDC 1500 HVDC-1700
 HVDC-1500

Drift HOW
[DHOW3-LG](#)
[DHOW6-LG](#)
[DHOW8-LG](#) } For structural gauges: 20, 18, 16

[DHOW3-HG](#)
[DHOW6-HG](#)
[DHOW8-HG](#) } For structural gauges: 14, 12

HOW
 DSLD (20ga)
 362
 600
 800

DSLD (12ga)
 362
 600
 800

DISC (INT)
 DESC (EXT)

Drift Rail
[DRC3-68](#)
[DRC6-68](#)
[DRC8-68](#)
[DRC3-97](#)
[DRC6-97](#)
[DRC8-97](#)
 DR97

DriftTrak DTSLB

DSSCB Drift Strut













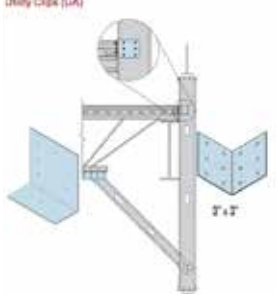
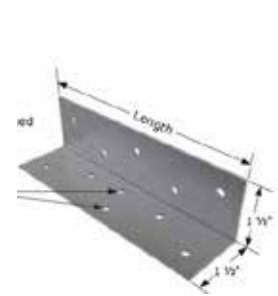
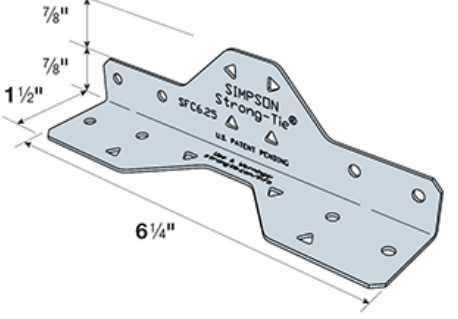

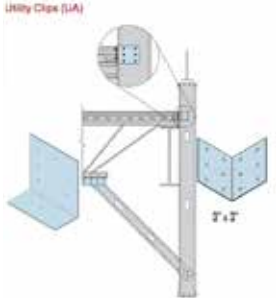
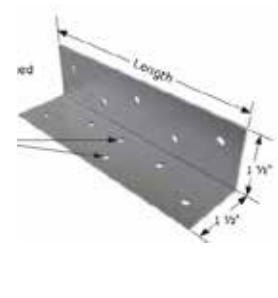

The Steel Network

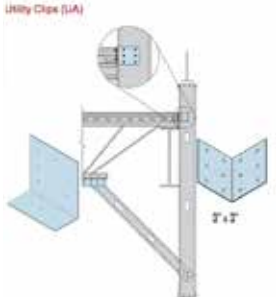
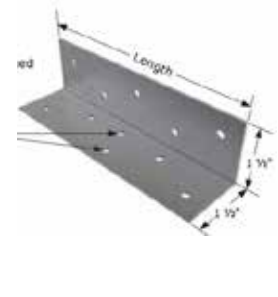
Marino/WARE

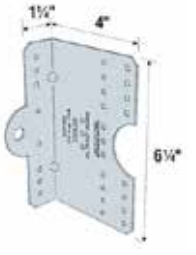
Craco

SCAFCO

CEMCO/Simpson

<p>S543 LS543 S545 LS545 S547 LS547 S549 LS549 S541 LS541</p> 			<p>UA113-16 UA115-16 UA118-16 UA119-16 UA1112-16</p>	<p>SFUA1.5x1.5x3.75-54 SFUA1.5x1.5x5.75-54 SFUA1.5x1.5x7.75-54 SFUA1.5x1.5x9.75-54 SFUA1.5x1.5x11.75-54</p>		<p>MA350-54 MA550-54 MA750-54 MA950-54</p>	<p>LSFC2.25-R300 or SFC2.25-R300 LSFC4.25-R175 or SFC4.25-R175 LSFC6.25-R125 or SFC6.25-R100</p> 
<p>S683 LS683 S685 LS685 S687 LS687 S689 LS689 S681 LS681</p> 			<p>UA113-14 UA115-14 UA118-14 UA119-14 UA1112-14</p>	<p>SFUA1.5x1.5x3.75-68 SFUA1.5x1.5x5.75-68 SFUA1.5x1.5x7.75-68 SFUA1.5x1.5x9.75-68 SFUA1.5x1.5x11.75-68</p>		<p>MA350-68 MA500-68 MA750-68 MA950-68</p>	 <p>RCA223 RCA225 RCA227 (16, 14, 12ga)</p> 
<p>S973 LS973 S975 LS975 S977 LS977 S979 LS979 S971 LS971</p> 			<p>UA113-12 UA115-12 UA118-12 UA119-12 UA1112-12</p>	<p>SFUA1.5x1.5x3.75-97 SFUA1.5x1.5x5.75-97 SFUA1.5x1.5x7.75-97 SFUA1.5x1.5x9.75-97 SFUA1.5x1.5x11.75-97</p>		<p>MA350-97 MA500-97 MA750-97 MA950-97</p>	
<p>E543 LE543 E545 LE545 E547 LE547 E549 E541</p> 			<p>UA143-16 UA145-16 UA148-16 UA149-16 UA1412-16</p>	<p>SFUA1.5x4x3.75-54 SFUA1.5x4x5.75-54 SFUA1.5x4x7.75-54 SFUA1.5x4x9.75-54 SFUA1.5x4x11.75-54</p>		<p>MB350-54 MB550-54 MB750-54 MB950-54</p>	 <p>LSSC4.25-R50 LSSC6.25-R30</p>
<p>E683 LE683 E685 LE685 E687 LE687 E689 E681</p> 			<p>UA143-14 UA145-14 UA148-14 UA149-14 UA1412-14</p>	<p>SFUA1.5x4x3.75-68 SFUA1.5x4x5.75-68 SFUA1.5x4x7.75-68 SFUA1.5x4x9.75-68 SFUA1.5x4x11.75-68</p>		<p>MB350-68 MB550-68 MB750-68 MB950-68</p>	 <p>SSC2.25-R125 SSC4.25-R50 SSC6.25-R30 SJC8.25-R15 SJC10.25-R15 MSSC2.25-R90 MSSC4.25-R50 MSSC6.25-R30 MSSC8.25-R15 MSSC10.25-R15</p>
<p>E973 LE973 E975 LE975 E977 LE977 E979 E971</p> 			<p>UA143-12 UA145-12 UA148-12 UA149-12 UA1412-12</p>	<p>SFUA1.5x4x3.75-97 SFUA1.5x4x5.75-97 SFUA1.5x4x7.75-97 SFUA1.5x4x9.75-97 SFUA1.5x4x11.75-97</p>		<p>MB350-97 MB550-97 MB750-97 MB950-97</p>	

RIGID CONNECTIONS

email: clipexpress@clarkdietrich.com
p: 866.638.1908



The Steel Network

Marino/WARE

Craco

SCAFCO

CEMCO/Simpson

Extended SwiftClip™ LE-Series

- [LE6816](#)
- [LE6818](#)
- [LE6820](#)
- [LE6824](#)
- [LE6830](#)
- [LE6836](#)

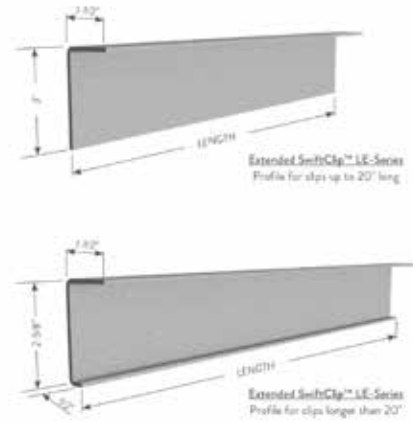

StiffClip LS
 LS < 20"
 LS > 20"

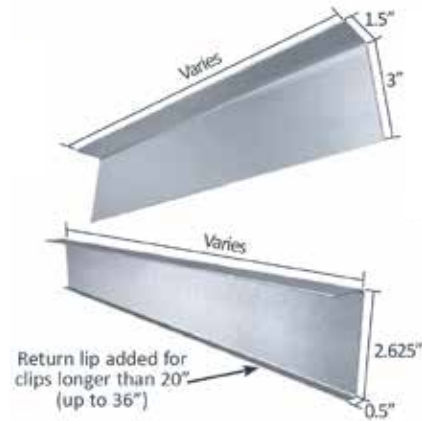

ByPass Fixed-Clip Strut
 FSB 3.518-R25

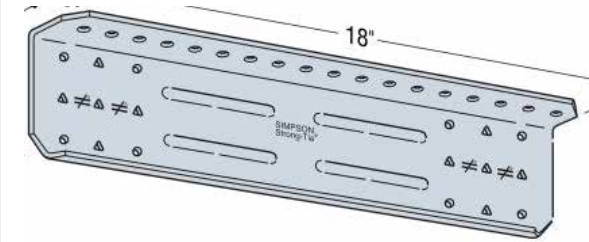

UXRC-HD w/5/8" Angle Hole



StiffClip Heavy Duty
 LB600-HD



Wall Tie Secure Clip
 WT-400
 WT-700
 WT-1000

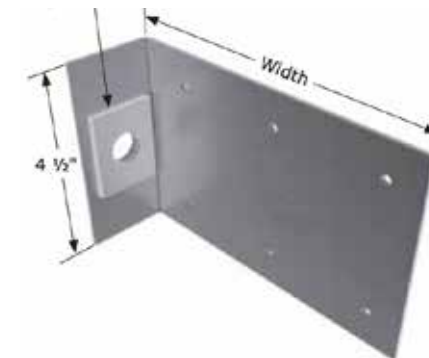

Heavy Duty ByPass Fixed-Clip
 FC32-5/97-R25
 FC62-5/97-R25
 FC62-5/118-R25
 FC82-5/118-R25

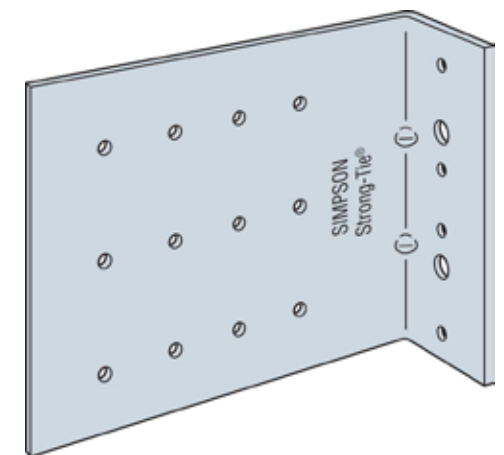



The Steel Network

Marino/WARE

Craco

SCAFCO

CEMCO/Simpson

SuperStud

FastBridge
[FB-43](#)
[FB-68](#)
[FB-33](#)

[CC33](#)

[U543](#) [LS543](#)
[U545](#) [LS545](#)
[U547](#) [LS547](#)
[U549](#) [LS549](#)

[U683](#) [LS683](#)
[U685](#) [LS685](#)
[U687](#) [LS687](#)
[U689](#) [LS689](#)

[U973](#) [LS973](#)
[U975](#) [LS975](#)
[U977](#) [LS977](#)
[U979](#) [LS979](#)



BridgeClip®, BC600/BC800

BridgeClip®
 US Patent #5,904,023

BC600/BC800

UA113-16, 14, 12
 UA115-16, 14, 12
 UA118-16, 14, 12
 UA1110-16, 14, 12

 Utility Clips (UA)

 SUBH-3.25 (18ga)
 MSUBH-3.25 (14ga)
 LSUBH-3.25 (20ga)

SFBC300/354
 SFBC600/654
 SFBC800

SFBC300

SFBC354

SFBC600

SFBC654

BC237
 BC337
 BC575
 BC775

SUBH-3.25 (18ga)
 MSUBH-3.25 (14ga)
 LSUBH-3.25 (20ga)

 Drywall Only
 DBC 2.5 (20ga)

QTWS 3.5" or 6"

8JS-362
 925JS-362
 1000JS-362
 1125JS-362
 1200JS-362
 1400JS-362

SFWS362/600-6"
 -8", 10", 12"

600WST350 or 600
 800WST350 or 600
 1000WST350 or 600
 1200WST350 or 600
 1400WST350 or 600



The Steel Network

Marino/WARE

Craco

SCAFCO

CEMCO/Simpson

EasyClip™ D-Series™ and T-Series™

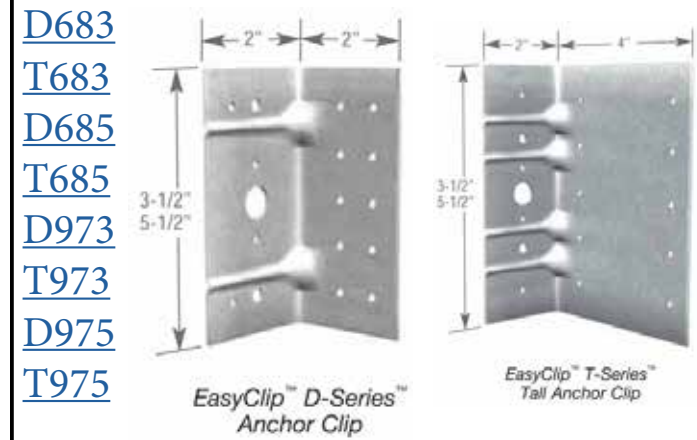

- [D683](#)
- [T683](#)
- [D685](#)
- [T685](#)
- [D973](#)
- [T973](#)
- [D975](#)
- [T975](#)

Stiff Clip CL Floor Tie



- CL362-68
- CL400-68
- CL600-68
- CL800-68

- RCC358 (1.5x4x3.25)
3-5/8 HDW Washer
- RCC600 (1.5x4x5.25)
600 HDW Washer
- RCC600 (1.5x4x5.25)
800 HDW Washer

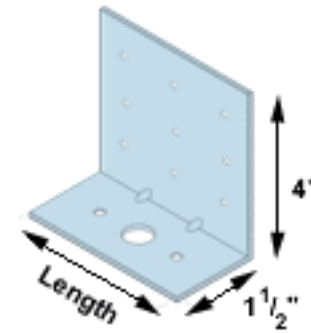

- SFTA300-54
- SFTA300-97
- SFTA600-54
- SFTA600-97

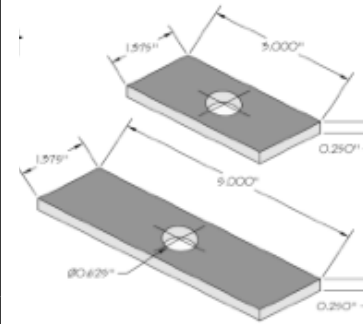

- FA337-68
- FA550-68
- FA750-68

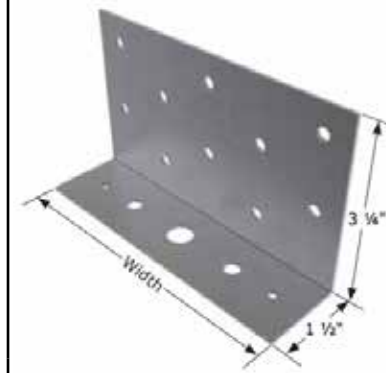

- MSSC4.25KW-KT20-BP1 Optional
- MSSC6.25KW-KT20-BP1 Optional

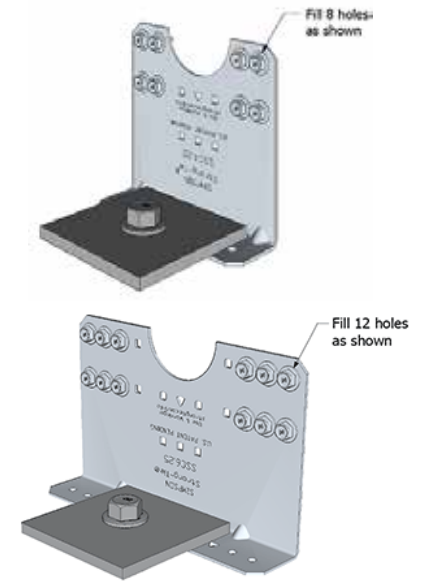

Moment Clips W/Plate

- [MC683](#) [MC973](#)
- [MC685](#) [MC975](#)
- [MC687](#) [MC977](#)

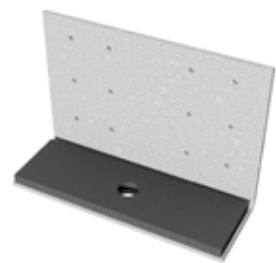

StiffClip CL w/(H) Plate

- | | |
|-------------|-----------|
| CL362-68(H) | CL362-118 |
| CL400-68(H) | CL400-118 |
| CL600-68(H) | CL600-118 |
| CL800-68(H) | CL800-118 |

- RCKW3 RCKW3S w/Stiffness
- RCKW5.5 RCKW5.5S w/Stiffness
- RCKW7.5

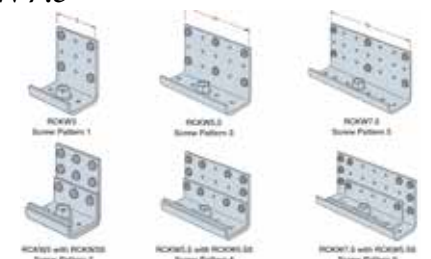

Uni-Clip™ End Clip & Extended Uni-Clip™

- [UCEC](#)
- [UXRC 6"](#)
- [UXRC 8"](#)
- [UXRC 10"](#)
- [UXRC 12"](#)

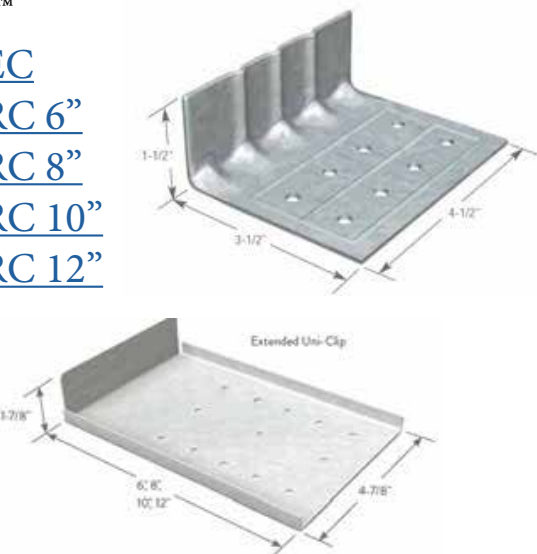

StiffClip LB Multi-Directional Load



- Resistant Angle
- LB362/400
 - LB600
 - LB800
 - LB1000
 - LB1200

- WRC362
- WRC600
- WRC800
- WRC1000
- WRC1200

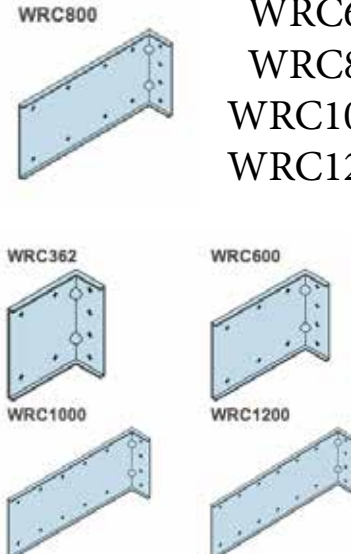

SFTC300, SFTC600, SFTC800, SFTC1000

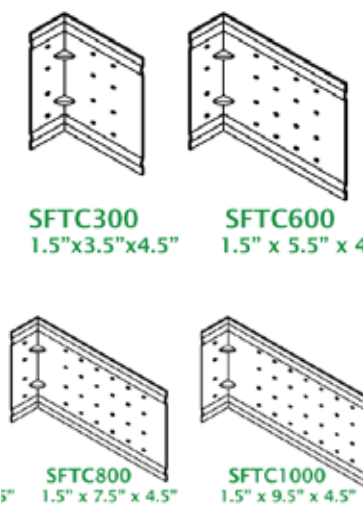

- AC350
- AC750
- AC750-2"OS
- AC950-2"OS



- FCB43.5
- FCB45.5
- FCB47.5
- FCB49.5
- FCB411.5

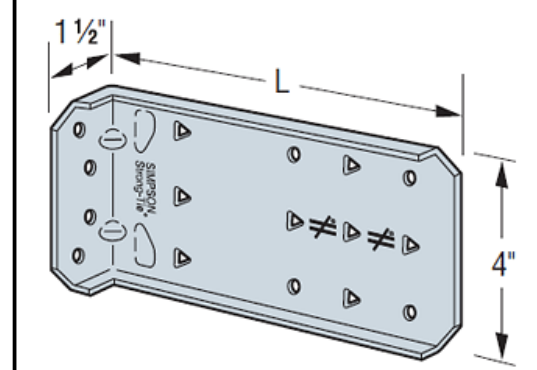



The Steel Network

Marino/WARE

Craco

SCAFCO

CEMCO/Simpson

H-Series™ Universal Header Hanger

H436
H546
H686

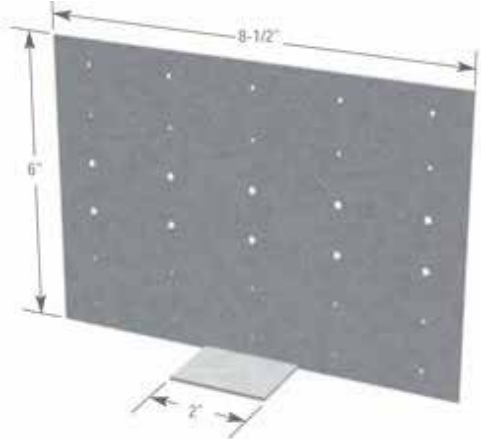

Stiff Clip HE Header Clip

HEH-68
HEL-43



HG-43
HG-68

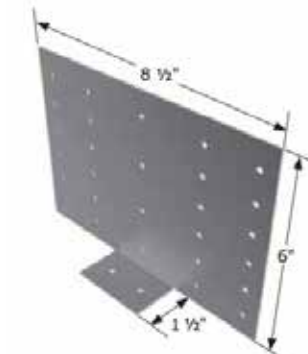

Uni-Clip™ End Clip

[UCEC](#)



EasyClip™ E-Series™ Clip

[E543](#)
[E683](#)
[E973](#)



Stiff Clip AL

AL362
AL600



SFAP

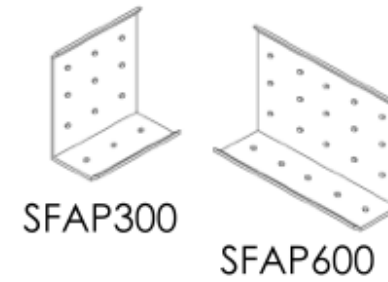

G436 *Unpunched sizes available.

G546
G686

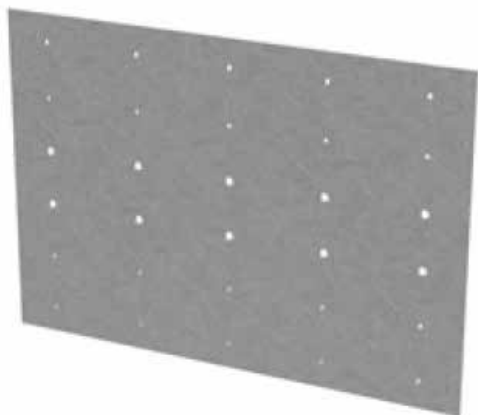

StiffClip PL Truss Plate Connector

Various Sizes



Unpunched Plates

Various Sizes

The Steel Network

Marino/WARE

Craco

SCAFCO

CEMCO/Simpson

[X543](#)
[X545](#)
[X547](#)
[X549](#)

[X683](#)
[X685](#)
[X687](#)
[X689](#)

[X973](#)
[X975](#)
[X977](#)
[X979](#)

BC600 or BC800 Bridge Clip

BridgeClip®
US Patent #5,904,023

BC600/BC800

UA223-16
UA225-16
UA228-16
UA2210-16

UA223-14
UA225-14
UA228-14
UA2210-14

UA223-12
UA225-12
UA228-12
UA2210-12

BC237, BC337
BC575, BC775

[A543](#) [LA543](#)
[A546](#) [LA545](#)
[A683](#) [LA683](#)
[A686](#) [LA685](#)
[A973](#) [LA973](#)
[A976](#) [LA975](#)

LA333

LA333-16 (3x3x3.25)
LA335-16 (3x3x5.25)
LA333-14 (3x3x3.25)
LA335-14 (3x3x5.25)
LA333-12 (3x3x3.25)
LA335-12 (3x3x5.25)

SFUA3"x3"x3.75"-54
x5.75"-54
x3.75"-68
x5.75"-68
x3.75"-97
x5.75"-97

MC350-54
MC550-54
MC350-68
MC550-68
MC350-97
MC550-97

SIMPSON
RCA333
RCA335
16, 14, 12ga

SUPERSTUD
AC 3X3

PREDRILLED HOLES
UPON REQUEST
(SPECIFY QUANTITY)



The Steel Network

Marino/WARE

Craco

SCAFCO

CEMCO/Simpson

Moment Clips 10GA:

- [MC103P](#)
- [MC105P](#)
- [MC107P](#)

- 1/4" Plate
- P338
- P538
- P738

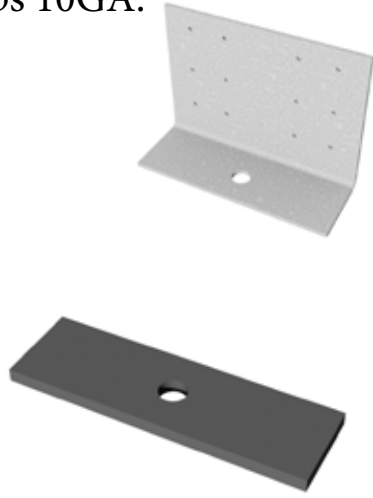

Stiff Clip CL W|H plate

- CL362-118
- CL400-118
- CL600-118
- CL800-118



- W|H Plate
- CL362-118(H)
- CL400-118(H)
- CL600-118(H)
- CL800-118(H)



Tension Tie
S/HTT14
S/LTT20

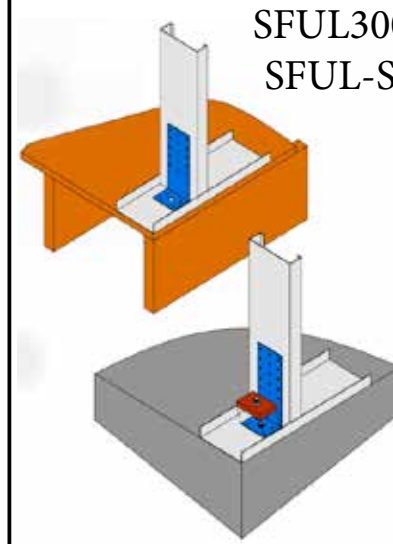

SFUL300-97
SFUL-SFBP

RCKW3S w/stiff
RCKW5.5S w/stiff

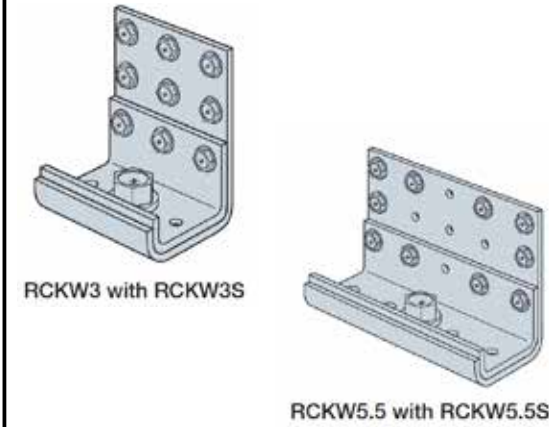

Skewable Angle

- [SA4](#)
- [SA6](#)
- [SA3](#)
- [SA5](#)
- [SA7](#)
- [SA9](#)



StiffClip HC Hip Connector

- HC600
- HC800



Skewable Angle

- SLS5
- SLS7



Skewable Angle

- SLS5
- SLS7



CD Holddown

- [CD8](#)
- [CD10](#)
- [CD15](#)



Stiff Clip TD



Holddown
S/HD8S
S/HD10S
S/HD15S



SFUL300-97
SFUL-SFBP

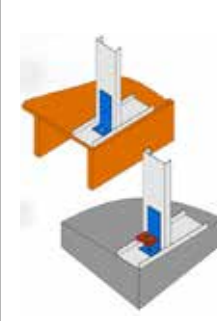

Holddown
S/HD8S
S/HD10S
S/HD15S



UJH
Universal
Joist Hanger
[UJH-68](#)
[UJH-97](#)



JC - Joist Clip



SJCT 14ga
SHJCT 12ga



SJCT 14ga
SHJCT 12ga





The Steel Network

Marino/WARE

Craco

SCAFCO

Simpson

Pony Wall

[PW24](#)
[PW36](#)
[PW48](#)



Mid Wall



Pony Wall

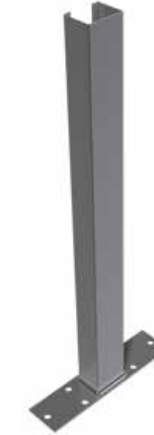

Bridle Hanger

CDBV
CDMB

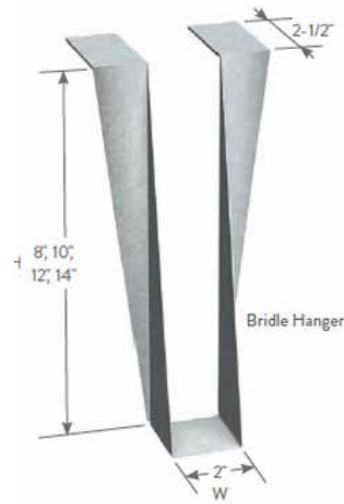

StiffClip JH



BH, S/BA (via Simpson)



S/LBV, S/B, S/BA Hangers



Floor Joist Blocking

800JB 12, 16, 14 O.C.
925JB 12, 16, 14 O.C.
1000JB 12, 16, 14 O.C.
1125JB 12, 16, 14 O.C.
1200JB 12, 16, 14 O.C.

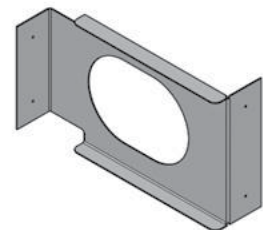

Solid Blocking (JB)

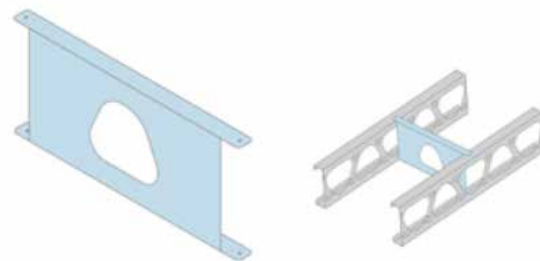

SMARTFRAME
Solid Blocking (SFSB)

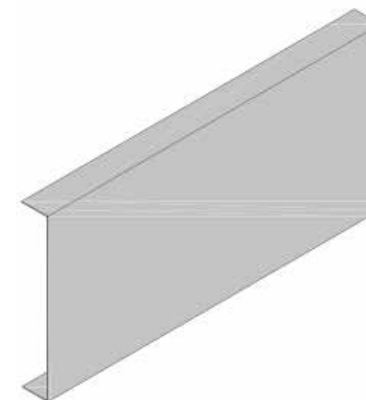



The Steel Network

Marino/WARE

Craco

SCAFCO

CEMCO/Simpson

Seismic & Hurricane Clips

- CDH2.0
- CDH2.5
- CDH2A
- CDH3

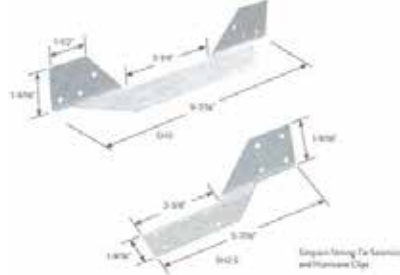

StiffClip RT Roof Tie



- RT1300
- RT650

- SH2
- SH25

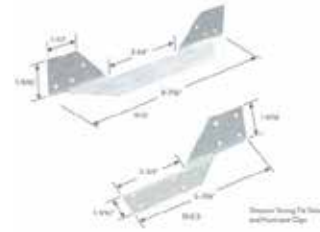

- TT1000
- TT600



- SH2
- SH25
- SH3

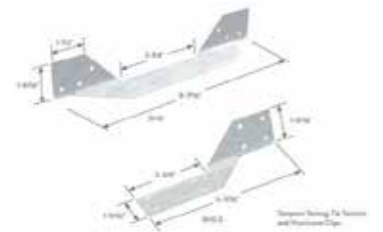

- LSTA24
- LSTA36
- MSTA24
- MSTA36
- KST224
- KST227
- KST237

Stiff Clip FS Floor Strut



- FS125-33
- FS125-43
- FS125-54
- FS125-68
- FS275-33
- FS275-68
- FS275-97

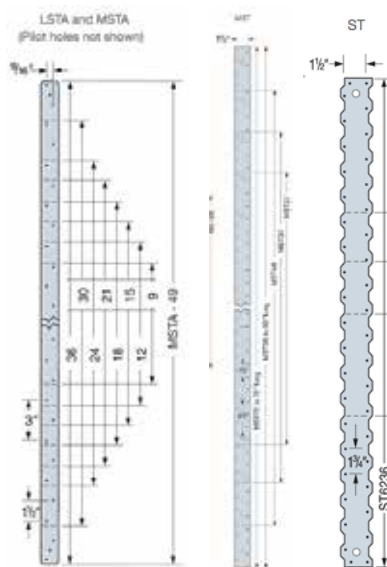

- LSTA24
- LSTA36
- MSTA24
- MSTA36
- ST6224
- MST27
- MST37

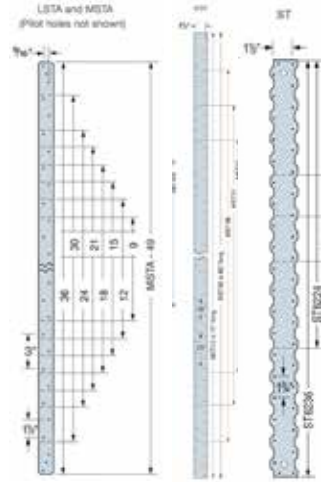

- LSTA24
- LSTA36
- MSTA24
- MSTA36
- ST6224
- MST27
- MST37

- RS150
- RS200
- RS250

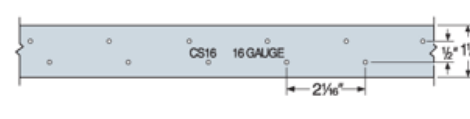

- CS16
- CS18
- CS20



- CS16
- CS18
- CS20

- MTW12

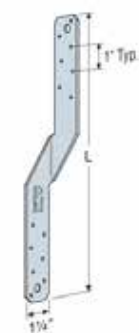

- MTS12



- MTS12

- N27

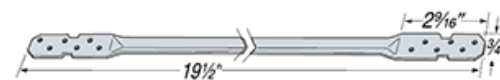

- TB27

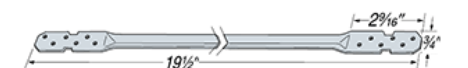

- TB27



The Steel Network

Marino/WARE

Craco

SCAFCO

MP6F

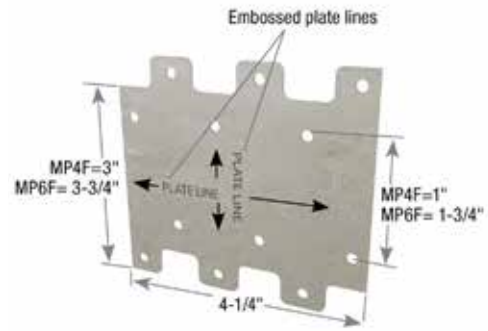

LTP5

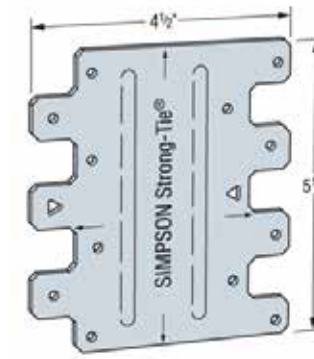

The CLAW

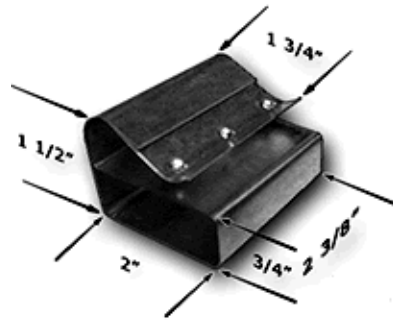

Grip Clip-Column Beam Clip

